

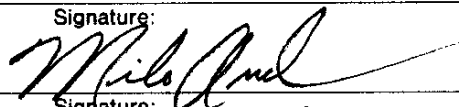
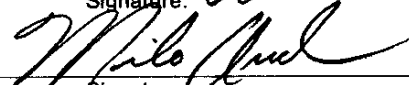

Raychem Energy Division

Report

Title		Pages:	12
EVALUATION AND PERFORMANCE OF S1119 RIBBON ADHESIVE		Enclosures:	
Report Number:	Date:		
EDR 5060	8/82		
Tested by:	Signature:	Date:	
Milo Anderson		9-21-82	
Prepared by:	Signature:	Date:	
Milo Anderson		9-21-82	
Approved by:	Signature:	Date:	
Robert Scott for Product Management		9/22/82	
Approved by:	Signature:	Date:	
Dan Magay for Technical Operations		9/30/82	
Raychem Corporation Energy Division			

CONTENTS

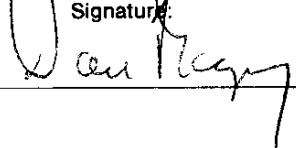
<u>Section</u>	<u>Page</u>
1. Basis	1
2. Objective	1
3. Physical Examination	2
4. HELB Testing	3
4.1 HELB Sample Preparation	3
4.2 Aging	4
4.3 Test Sequence	4
4.3.1 Water Immersion	5
4.3.2 Insulation Resistance	5
4.3.3 Voltage Withstand	5
4.3.4 Simulated HELB	5
5. Test Results	6
5.1 Physical Examination Results	6
5.2 HELB Test Results	6
5.2.1 Visual Examination	6
5.2.2 Functional Testing	7
6. Conclusion	7
7. Figures	8
7.1 Application Diagram	8
7.2 Test Set-up	9
7.3 HELB Vessel	9
7.4 Time versus Temp./Press. Profile	10
8. Table	
8.1 Electrical Performance	10
9. Attachments	
9.1 QA Verification (Materials and Configuration)	11
9.2 QA Verification (Testing and Equipment Calibration)	12

1. Basis

S1119 is now being manufactured in the ribbon form which is intended to replace the S1024 ribbon adhesive in those applications where precoated parts are not used. This document reports the results of the evaluations and functional testing done to confirm the adequacy of the S1119 adhesive in ribbon form and completes the transition from S1024 (designated /83 or -N in product descriptions) to S1119 (designated /144 or -N).

Initially, S1024 was replaced by S1119 in precoated tubing and molded parts. These products went through extensive material and functional product tests, the results of which are discussed in EDR 5021, Qualification Report Supplement for Raychem Nuclear Grade Adhesive - S1119. This report concluded S1119 adhesive to be "equal to or superior to" the S1024 adhesive in those applications. S1119 ribbon adhesive is the same formulation as S1119 used in the precoated parts.

2. Objective

The objective of this supplemental report is to evaluate the ability of the ribbon form of Raychem's S1119 adhesive to perform the functional requirements in typical product applications. This extends the material evaluation of the same adhesive previously documented in EDR 5021 for precoated heat shrinkable parts.

The function of the ribbon adhesive is to provide an environmental seal for isolating the active electrical components from moisture, contamination, etc. The requirements necessary to perform its intended function are that it conform to the substrate when tubing is recovered over it using normal Raychem procedures, and that it maintain seal integrity during normal service and accident conditions such as a High Energy Line Break (HELB).

3. Physical Examination

At this time, the S1119 ribbon adhesive is intended to be used with Raychem Nuclear High Voltage Terminations (NHVT'S) and Raychem Nuclear Motor Connection Kits-8 kV (NMCK8'S). The typical substrates over which the S1119 would be applied when used with NHVT'S would be crimped terminal lugs and various cable jackets. The typical substrates when used with NMCK8'S would be various motor leads, cable jackets and Raychem BBIT and HVTM tubings.

To evaluate the S1119 ribbon's ability to conform to the substrates which would be encountered when applied with NHVT's, the ribbon adhesive was applied to terminal lugs and then sectioned for visual inspection. Crimped terminal lugs were chosen as the test substrate due to the very uneven surface and the effect of the lug as a heat sink. Two types of lugs were used for the evaluation. A 500 mcm, Burndy, Aluminum lug, YA34A3, was used to evaluate severe indentations. A 350 mcm, Burndy, Copper lug, YA31-2N, was used to evaluate the effect of the lug as a heat sink. Adhesive was applied over the terminal lugs in amounts varying from 1 to 5 layers. Raychem 42/19 HVTM was recovered on 350 mcm lugs and 51/26 HVTM was recovered on the 500 mcm lugs over the S1119 adhesive using a Thermogun CV-5000, Model 750 and a FH-2609 propane torch. Two samples of each lug type using the Thermogun and two samples using the torch were prepared to insure independence from tubing recovery methods. A total of 20 samples were prepared for the evaluation of this application.

To evaluate the S1119 ribbon's ability to conform to the substrates which would be encountered when applied with NMCK8's, the ribbon was applied to motor lead and then sectioned for visual inspection. Westinghouse Electric, silicone rubber tape insulated motor lead, O.D. 0.544," was chosen as the test substrate due to the rough surface and the spiral cracks created by the tape

insulation. S1119 ribbon was applied over the motor lead in amounts varying from 1 to 2 layers. Raychem 25/10 BBIT was recovered over the adhesive. Again two samples were prepared using the Thermogun and two using the torch for each adhesive thickness. A total 8 samples were prepared for the evaluation of this application.

The samples described above were allowed to cool to room temperature and were then cut open for inspection. The results of these inspections are reported in Section 5.

4. HELB Testing

To evaluate the S1119 ribbon's ability to maintain seal integrity, a simulated High Energy Line Break (HELB) was performed. The silicone rubber motor lead described in Section 3 was chosen as the test substrate. This motor lead had been used in a HELB which was conducted as part of the qualification of the NMCK8, the results of which are reported in EDR 5037, Performance Test of 8kV, In-Line Type Motor Connection Splices. The same temperature and time as used in EDR 5037 were used for this test (348°F for four hours). Performing electrical testing before and after the HELB and physical examination would then determine whether or not a leak path had been formed.

4.1 HELB Sample Preparation

Six samples were prepared, three with Raychem HVTM, 19/10 and three with Raychem BBIT, 25/10 recovered over the adhesive. The motor lead was center cut to expose the conductor and one wrap of S1119 was applied on each side of the exposed conductor with the tubing recovered to envelop both adhesive layers. (See Attachments 9.1 and 9.2 for application diagram and QA verification.)

Adhesive coated end caps were recovered over each end of cable to seal the ends.

Sample Matrix

<u>Sample</u>	<u>Tubing</u>	<u>Motor Lead O.D.</u>
1	HVTM 19/10	0.544"
2	HVTM 19/10	0.544"
3	HVTM 19/10	0.544"
4	HVTM 25/10	0.544"
5	HVTM 25/10	0.544"
6	HVTM 25/10	0.544"

4.2 Aging

The aging properties of S1119 adhesive were extensively reported in EDR 5021, Section 3.1. As the ribbon adhesive is a form change only and involves no formulation change, this testing was not repeated.

4.3 Test Sequence

The test program consisted of the following sequence:

<u>Sequence</u>	<u>Test</u>	<u>Section</u>
1	Water Immersion	4.3.1
2	Insulation Resistance	4.3.2
3	Voltage Withstand	4.3.3
4	Simulated HELB	4.3.4
5	Water Immersion	4.3.1
6	Insulation Resistance	4.3.2

4.3.1 Water Immersion

Test samples were immersed in tap water at room temperature for 24 hours.

4.3.2 Insulation Resistance

Samples were measured at 500 volts DC, in water, at room temperature after 1 minute energization. (ASTM D257-78)

Requirement: $R > 2.5$ megohms.

4.3.3 Voltage Withstand

The withstands were performed in water per IEEE Std. 383-1974, Section 2.3.3.4, using equipment as described in ASTM D149-75. Since the sample length allowable was limited by the size of the test apparatus, 4000 volts was the maximum voltage which could be applied. This resulted in a minimum stress of 2000 volts per inch along the length of the seal. The stress across the HVTM at this voltage was 105 volts/mil versus the 80 volts/mil required.

Requirement: No Breakdown.

4.3.4 Simulated HELB

The HELB simulation was conducted using a stainless steel Parr pressure vessel, Model 4551, with a 1-gallon capacity (see Figure 7.2). The vessel is equipped with an automatic temperature control and heater. System temperature was cross-checked with an Omega Digital Thermometer (see Attachment 9.2, QA Verification). Both systems probed the temperature of the vessel from a thermowell extending into the vessel. The vessel is also equipped with an

A. Biederman Pressure Gauge, Serial No. 001, Range 0-200 psi (see Attachment 9.2, OA Verification).

After the voltage withstand testing, the exposed ends of the samples were capped and the samples were placed in the vessel. Approximately 1/3 the volume of the vessel was then filled with water (see Figure 7.3). The vessel temperature was raised to 348°F and held for 4 hours (see Figure 7.4).

5. Test Results

5.1 Physical Examination Results

Examining the samples described in Section 3, the S1119 adhesive looked very good. The S1119 had melted and flowed, filling the deformities of the substrates. Even with 5 layers of S1119 and no preheating of the lug, there was still acceptable flow.

5.2 HELB Test Results

5.2.1 Visual Examination

Visual inspection showed all samples to be in acceptable condition after removing them from the test vessel. There was some discoloration of the HVTM and BBIT tubing, which was expected after being subjected to these test conditions. There was also some flow of the adhesive from under the tubing, which was also to be expected.

When the samples were dissected the surface of the adhesive showed that it had filled all the deformities in the cable insulation with no evidence of leak paths. No moisture was found inside the samples.

5.2.2 Functional Testing

All samples passed the insulation resistances and voltage withstands before and after the simulated HELB (see Table 8.1).

6. Conclusion

On the basis of the evaluations and testing of the S1119 adhesive in tape form, Raychem concludes that the results of the type test done on Raychem product configurations obtained using S1024 adhesive are applicable to those same product configurations using S1119 without further requalification.

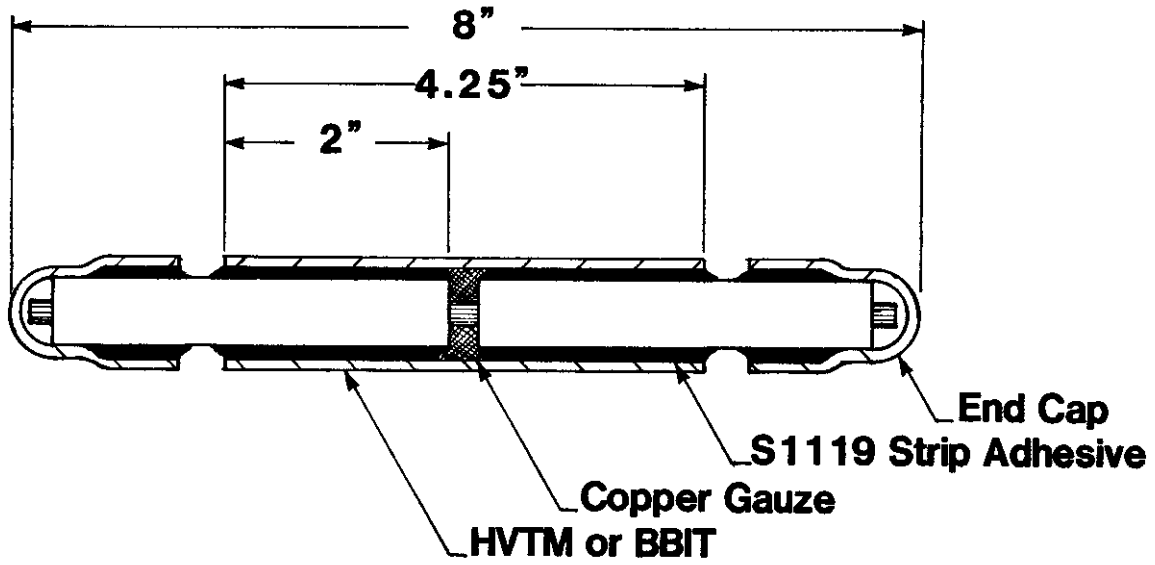

Figure 7.1 Application Diagram

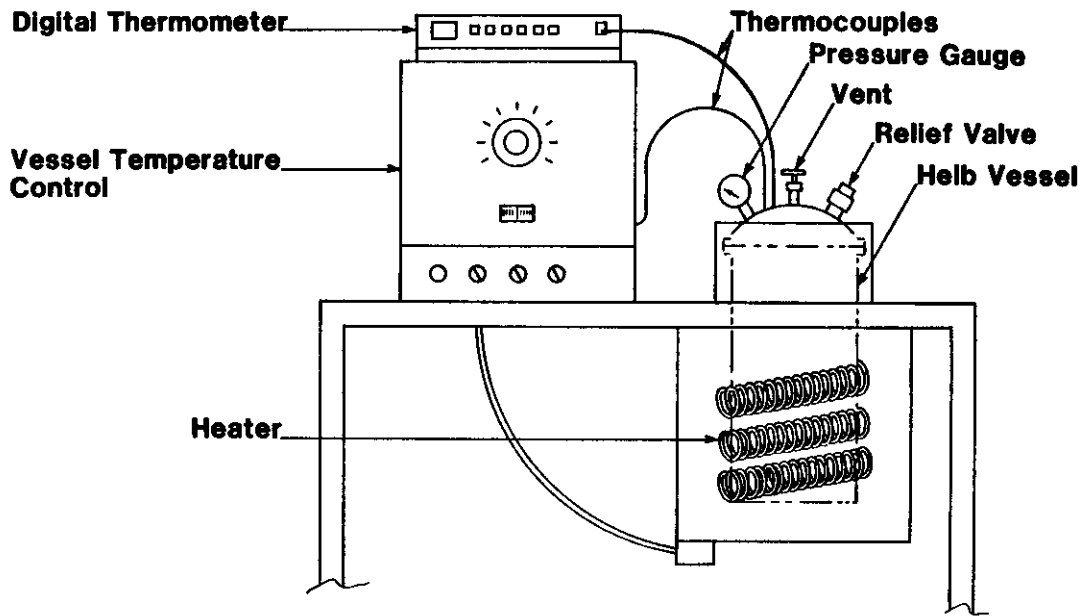

Figure 7.2 Test Set-up

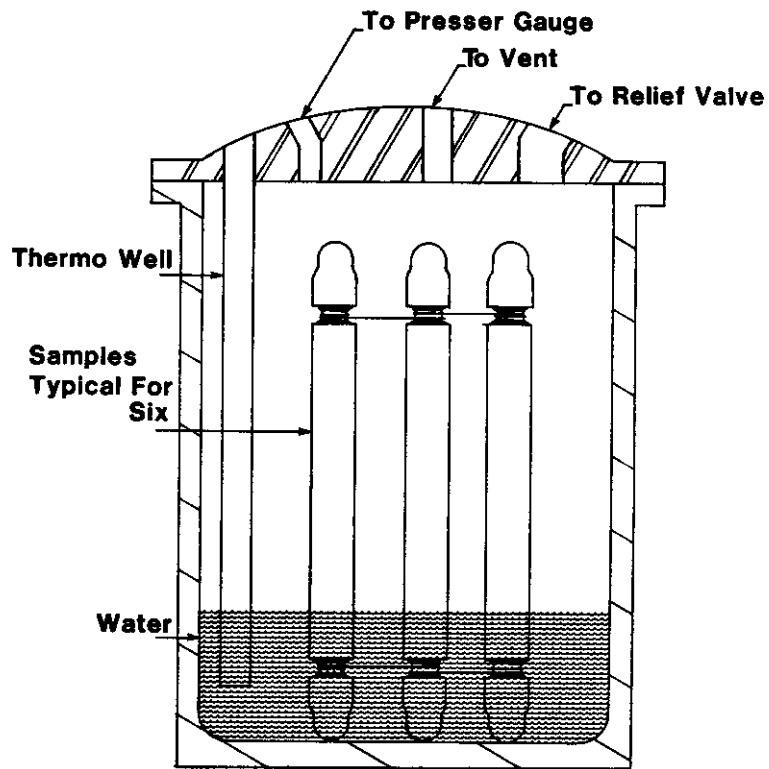

Figure 7.3 HELB Vessel (Internal View)

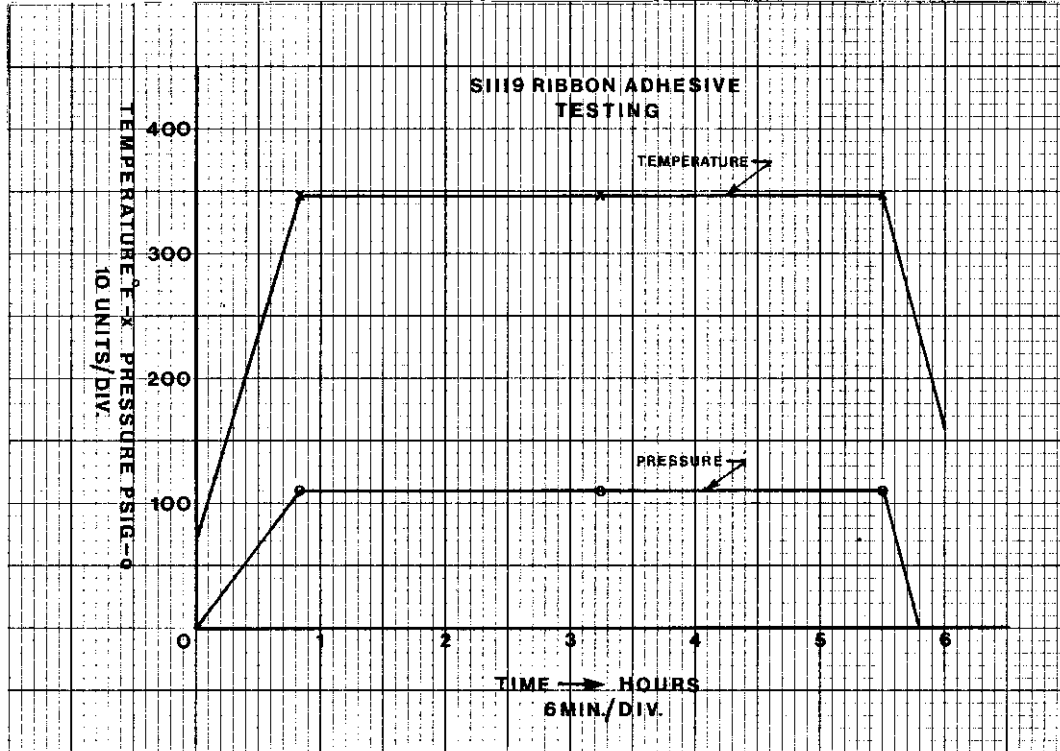

Figure 7.4 Time versus Temp./Press.Profile

Sample	Insulation Resistance at 500 VDC after 1 min.		Voltage Withstand of 4000 volts for 5 min.	
	Before	After	Before	After
HVTM 1	8.2×10^{11} Ohms	2×10^9 Ohms	All	All
2	8.2×10^{11} Ohms	1.3×10^9 Ohms	Passed	Passed
3	5×10^{10} Ohms	1.1×10^9 Ohms		
BBIT 4	9.6×10^{11} Ohms	7×10^8 Ohms	All	All
5	8.3×10^{11} Ohms	1.6×10^9 Ohms	Passed	Passed
6	4×10^{10} Ohms	6×10^8 Ohms		

Table 8.1 Electrical Performance

Raychem

ENERGY DIVISION - AMPAC

QUALITY ASSURANCE

QUALIFICATION TEST PLAN # NPE-TP-82-06
VERIFICATION OF TEST SPECIMEN CONFIGURATION

REFERENCE SPEC. (PCD, SMO, OTHER): SMO MO-5-3362, MS 180, MS 323

PRODUCT NAME: S-1119 Ribbon Adhesive

NUMBER OF SPECIMENS PREPARED: 3 of ea. configuration

THE FOLLOWING COMPONENT MATERIALS WERE TESTED AND DETERMINED TO BE IN CONFORMANCE WITH APPLICABLE RAYCHEM PRODUCT SPECIFICATIONS.

	<u>DESCRIPTION</u>	<u>LOT NUMBER</u>	<u>QTY. PER SPECIMEN</u>
1.	S-1119 Ribbon SMO-5-3362	P4620-6	2 pc.
2.	HVTM 19/10 MS180	T2004-43	1 pc.
3.	BBIT 25/10 MS323	X8/1584-05	1 pc.
4.			
5.			
6.			
7.			
8.			
9.			
10.			

ENERGY QUALITY ASSURANCE WITNESSED THE ASSEMBLY OF THE ABOVE COMPONENTS INTO THE CONFIGURATION SPECIFIED IN TEST PLAN # NPE-TP-82-06.

VERIFIED BY:

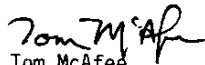

Tom McAfee
 Assoc. Quality Assurance Engineer

DATE: 8-24-82

ENQA-108 (3/82)

Attachment 9.1 QA Verification

Raychem

ENERGY DIVISION - AMPAC

QUALITY ASSURANCE

QUALIFICATION TEST PLAN # NPE-TP-82-06
VERIFICATION OF TEST PROCEDUREREFERENCE SPEC: ASTM C119.1-1974, ASTM D257-78 and EDR-5037PRODUCT NAME: S-1119 Ribbon AdhesiveNUMBER OF SPECIMENS TESTED: 6 ea.ENERGY QUALITY ASSURANCE WITNESSED THE TESTING OF THE ABOVE SPECIMENS FOR DETERMINATION
OF Seal Integrity of S-1119 Ribbon Adhesive
PER THE REQUIREMENTS OF The above mentioned specifications AND THE TEST PLAN.THE FOLLOWING MEASURING AND TEST EQUIPMENT WAS USED AND WAS PROPERLY AND CURRENTLY
CALIBRATED AT THE TIME OF THE TEST.

IDENTIFYING NO.	DESCRIPTION	CAL
1. <u>EQC 110</u>	<u>Megohmmeter</u>	<u>In Cal</u>
2. <u>EQC 106</u>	<u>A C Hipot</u>	<u>In Cal</u>
3. <u>001</u>	<u>A. Biederman Pressure Gauge</u>	<u>In Cal</u>
4. <u>EQC 141</u>	<u>Digital Thermometer</u>	<u>In Cal</u>
5. _____	_____	_____
6. _____	_____	_____
7. _____	_____	_____
8. _____	_____	_____
9. _____	_____	_____
10. _____	_____	_____

VERIFIED BY:

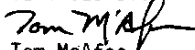
Tom McAfee
Associate Q. A. EngineerDATE: 8-24-82

ENQA-126 (3/82)

Attachment 9.2 QA Verification