

SuperBullet™

Rugged GbE Media Converter Solutions for MFOCA® Field Deployable Applications DDS-M Remote

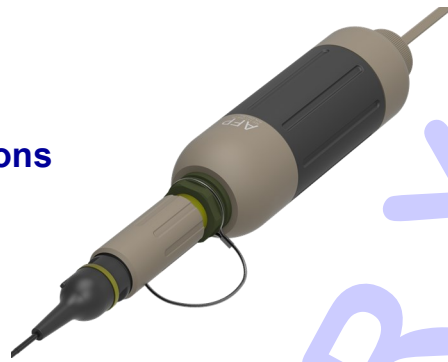

Field
Deployable
GbE
Solutions

Product Overview

The light-weight rugged SuperBullet™ extends the distance of GbE for field deployable applications between routers, switches, converters and related Ethernet based systems, including a terrestrial wideband radio system, using the single mode pair of an MFOCA® cable assembly.

The SuperBullet™ is locally powered by Power over Ethernet (PoE). It features an MFOCA® bulkhead interface, one IP67 rated RJ45 port, and is housed in a robust light-weight IP67 hard anodized aluminum enclosure.

The SuperBullet™ is pre-configured with a single channel, GbE media converter utilizing 2 singlemode fibers.

(Consult factory for multimode and 10GbE options.)

Key Features

- SIGNAL: 10/100/1000 Mbps Ethernet
- TRANSMISSION DISTANCE:
 - GbE: Up to 5 Km
- SPECIFICATIONS:
 - MIL-STD-461F (Requirements for Control of EMI Characteristics of Subsystems and Equipment)
 - MIL-STD-810G (Test Method Standard)
 - IP67 (Immersion Protection, Dust Tight and Protected against immersion in up to 1 meter of water.)
 - 10BASE-T, 100BASE-TX, 1000BASE-T, 1000BASE-X (Ethernet)
- POWER:
 - Local power source - PoE
 - <5 watts
- CONFIGURATION OPTIONS (Contact factory):
 - Surge Protected, IP67 rated, MIL D38999 RJ45 Interface
 - 10 GbE Singlemode
 - 850nm or 1300nm Multimode
 - > 5Km link distance

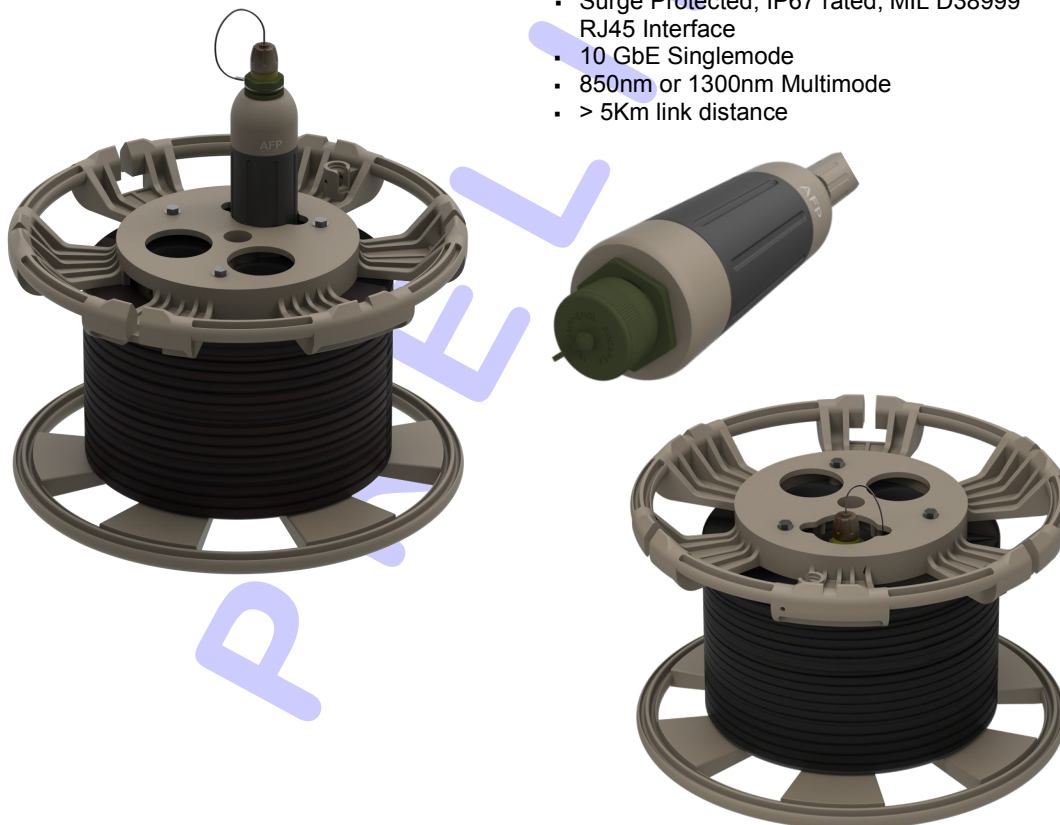

Advanced Fiber Products LLC
200 East Howard Ave, Suite 244
Des Plaines, IL, USA 60018
Tel: +1-847-768-9001
E-mail: video@afpgco.com

Wholly owned subsidiary of
Advanced Fiber Products Ltd
Hollands Road
Haverhill, Suffolk
England CB9 8PR

Tel: +44 (0) 1440-706441
Fax: +44 (0) 1440-762044
E-mail: sales@afpgco.com

**Advanced
Fiber
Products**

www.afpgco.com

SuperBullet™ MFOCA®
Product Sheet Rev 16120.00

MFOCA® is a registered trademark of Cinch Connectivity Solutions under Reg. No. 4,585,103

Advanced Fiber Products Limited is a company registered in England and Wales Registration number – 6431612



VAT number GB 923 3146 47

Page 1 of 3

SuperBullet™

Rugged GbE Media Converter Solutions for MFOCA® Field Deployable Applications

DDS-M Remote

ORDERING INFORMATION ▶	SBSIP-GBE-MF-SM-yy*	SBSIP-GBE-MF-MM-yy*	SBSIP-10GBE-MF-SM-yy*
PARAMETER ▼			
Ethernet	10/100/1000 Mbps	10/100/1000 Mbps	10Gbps
Number of Fibers	2 Singlemode	2 Multimode	2 Singlemode
Transceiver Type	Blank: F-P 1310nm TX / PIN RX -yy: DFB CWDM TX / PIN RX	-85: 850nm TX / PIN RX -30: 1300nm TX / PIN RX	-Blank: F-P 1310nm TX / PIN RX -yy: DFB CWDM TX / PIN RX
Fiber Connector	MFOCA®	MFOCA®	MFOCA®
Data Connector	IP67 RJ45	IP67 RJ45	IP67 RJ45
Power	PoE	PoE	PoE

*Specify 2-digit TX wavelength code, yy: **Singlemode:** Blank = 1310nm Fabry-Perot; CWDM Wavelengths: 31=1310, 33=1330, 35=1350, 37=1370, 39=1390, 41=1410, 43=1430, 45=1450, 47=1470, 49=1490, 51=1510, 53=1530, 55=1550, 57=1570, 59=1590 and 61=1610 nm.

Multimode: 85 = 850nm, 30 = 1300nm

SPECIFICATIONS

Item	Description
Protocols 10/100/1000 Mbps	10BASE-T, 100BASE-TX, 1000BASE-T, 1000BASE-X
Frame Size	10,240 byte maximum
SBSIP-GBE-MF-SM (Fabry-Perot 1310nm TX / PIN RX, GbE Media Converter), Optical Power	Transmitter: -9 dBm Minimum, -3 dBm Maximum Receiver: -20 dBm Minimum, -1 dBm Maximum
SBSIP-GBE-MF-SM-yy (CWDM TX / PIN GbE Media Converter), Optical Power	Transmitter: 0 dBm Minimum, +3 dBm Maximum Receiver: -20 dBm Minimum, -1 dBm Maximum
SBSIP-GBE-MF-MM-yy (1GbE Multimode)	Consult factory for multimode performance.
SBSIP-10GBE-MF-SM-yy (10GbE Singlemode)	Consult factory for 10GbE performance.
Link Length (singlemode fiber)	Ethernet 10/100/1000 Mbps: Up to 5 km
Operating / Storage Temperature	-35 C to +75 C / -40 C to +85 C
Weight	2.2 lbs 1.0 Kg

Dimensions, Inch [cm]

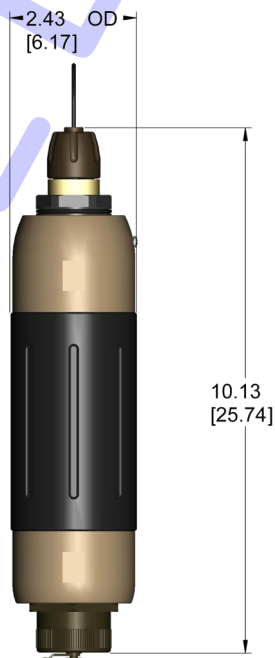

Advanced Fiber Products LLC
200 East Howard Ave, Suite 244
Des Plaines, IL, USA 60018
Tel: +1-847-768-9001
E-mail: video@afpgco.com

Wholly owned subsidiary of
Advanced Fiber Products Ltd
Hollands Road
Haverhill, Suffolk
England CB9 8PR

Tel: +44 (0) 1440-706441
Fax: +44 (0) 1440-762044
E-mail: sales@afpgco.com

**Advanced
Fiber
Products**

www.afpgco.com

SuperBullet™ MFOCA®
Product Sheet Rev 161200

SuperBullet™

Rugged GbE Media Converter Solutions for MFOCA® Field Deployable Applications

DDS-M Remote

Field
Deployable
GbE
Solutions

Related Products — Contact Factory

SuperChassis™ Tactical Fiber Mux



SuperDrum™



40Gbps SuperChassis™ Mini



MFOCA® and Expanded Beam Tactical Cable Assemblies

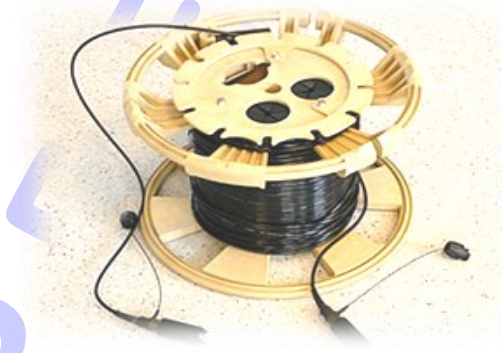

Advanced Fiber Products, LLC (AFP-US) develops and manufactures active optical devices engineered and packaged to withstand the rigors of broadcast production and many industrial environments. The devices are designed to convert signals from electrical to optical domain, aggregate, multiplex and de-multiplex them and provide transmission via ruggedized cabling solutions. AFP also offers a wide range of ancillary components in addition to specialized fiber assemblies related to high performance optical hermeticity, laser-to-fiber or fiber-to-detector delivery and integration into complete packaging solutions. AFP-US located near Chicago, Illinois, USA is a wholly owned subsidiary of Advanced Fiber Products Ltd. (AFP). The company is headquartered at Haverhill, near Cambridge in the United Kingdom.

Advanced Fiber Products LLC
200 East Howard Ave, Suite 244
Des Plaines, IL, USA 60018
Tel: +1-847-768-9001
E-mail: video@afpgco.com

Wholly owned subsidiary of
Advanced Fiber Products Ltd
Hollands Road
Haverhill, Suffolk
England CB9 8PR
Tel: +44 (0) 1440-706441
Fax: +44 (0) 1440-762044
E-mail: sales@afpgco.com

Advanced
Fiber
Products

www.afpgco.com

SuperBullet™ MFOCA®
Product Sheet Rev 16120.00

Advanced Fiber Products reserves the right to change or discontinue any product or service in this publication and advises customers to obtain the latest versions of publications before placing orders. Patents are pending. Advanced Fiber Products standard warranty conditions apply and are available upon request. Advanced Fiber Products customers using its products in life preserving applications where the reasonable malfunction of the products might be expected and may result in personal injury, agree to indemnify Advanced Fiber Products against all such improper use and any consequential damages. Advanced Fiber Products makes no representations or warranties that the products are free from patent, copyright or intellectual property rights. Standard Terms and Conditions of sale apply and are available on request.

SuperBullet™

Rugged GbE Media Converter Solutions for MFOCA®

DDS-M Remote



Field
Deployable
GbE
Solutions

SuperBullet™ Product Overview

The light-weight rugged SuperBullet™ extends the distance between a remote GbE router or switch location and a terrestrial wideband radio system using the single mode pair on a MFOCA® cable assembly.

The SuperBullet™ is locally powered by PoE. It features a MFOCA® bulkhead interface, one IP68 rated MIL D38999 RJ45 port, and is housed in a robust light-weight IP68 aluminum enclosure.

The SuperBullet™ is pre-configured with a single channel GbE media converter.

Key Features

- SIGNAL: 10/100/1000 Mbps Ethernet
- TRANSMISSION DISTANCE:
 - GbE: Up to 5 Km
- SPECIFICATIONS:
 - MIL-STD-1275E
 - MIL-STD-461F
 - MIL-STD-810G
 - IP68
- POWER:
 - Local power source - PoE
 - <5 watts
- CONFIGURATION OPTIONS (Contact factory):
 - Surge Protected IP68 rated MIL D38999 RJ Interface
 - 10 GbE Singlemode
 - 850nm or 1300nm Multimode.
 - > 5Km link distance

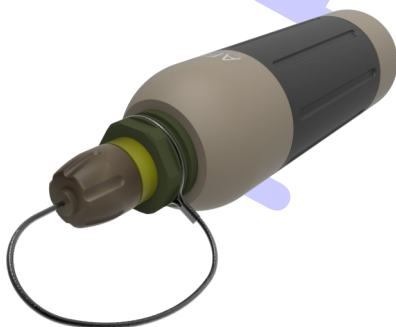

Advanced Fiber Products LLC
200 East Howard Ave, Suite 244
Des Plaines, IL, USA 60018
Tel: +1-847-768-9001
E-mail: video@afpgco.com

Wholly owned subsidiary of
Advanced Fiber Products Ltd
Hollands Road
Haverhill, Suffolk
England CB9 8PR

Tel: +44 (0) 1440-706441
Fax: +44 (0) 1440-762044
E-mail: sales@afpgco.com

**Advanced
Fiber
Products**

www.afpgco.com

SuperBullet/Case™
Product Sheet Rev 15321.01

SuperCase™

**Rugged GbE Media Converter
Solutions for MFOCA®**

DDS-M Remote

Single or Multiple Channels



**Field
Deployable
GbE
Solutions**

Product Overview

The light-weight rugged *SuperCase™* extends the distance between a remote GbE router or switch location and a terrestrial wideband radio system.

The *SuperCase™* is locally powered by PoE or 12VDC. It features an MFOCA® bulkhead interface, 1 to 4 IP68 rated MIL D38999 RJ45 ports, an IP68 rated MIL D38999 power connector, and is housed in a robust light-weight IP68 enclosure.

The *SuperCase™* is pre-configured with a single channel GbE media converter. For channel expansion, the CWDM option allows the addition of up to 3 more GbE channels over the same 2 single-mode fibers of a MFOCA® fiber optic interface. In addition, a rugged IP68 LC multimode adapter is provided so that the 2 multimode fibers of the MFOCA® interface can also be utilized.

Key Features

- **SIGNALS:**
 - Supplied as 1-4 10/100/1000 Mbps Ethernet links
- **ENCLOSURE**
 - Easy top-side access for field service and re-configuration
 - IP68 rated multimode duplex LC adapter for access to the multimode fiber pair.
- **TRANSMISSION DISTANCE:**
 - GbE: Up to 5 Km
- **SPECIFICATIONS:**
 - MIL-STD-1275E
 - MIL-STD-461F
 - MIL-STD-810G
 - IP68
- **POWER:**
 - Local power source can be PoE or 12VDC
 - 3 to 15 watts depending on channel count
 - Simultaneous power supply connection provides power redundancy
- **CONFIGURATION OPTIONS (Contact factory):**
 - > 5Km link distance
 - Expansion capability up to 40G
 - Other signal protocols can be multiplexed simultaneous over the same fibers, e.g. video.
 - Surge Protected IP68 rated MIL D38999 RJ Interface.



SCSIP-GBE-MF-04
4 Channel Configuration

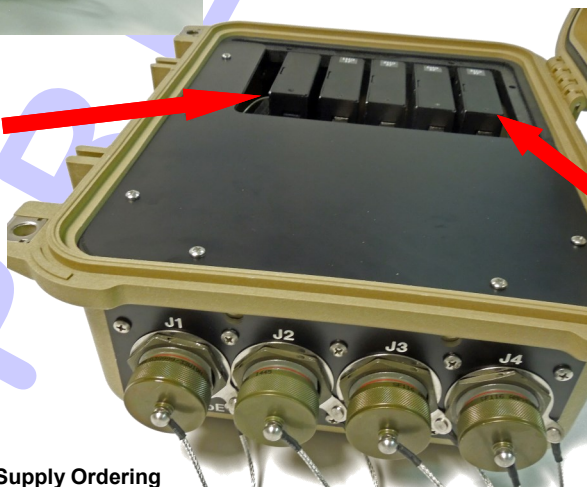

SCSIP-GBE-MF-01
1 Channel Configuration

Advanced Fiber Products LLC
200 East Howard Ave, Suite 244
Des Plaines, IL, USA 60018
Tel: +1-847-768-9001
E-mail: video@afpgco.com

Wholly owned subsidiary of
Advanced Fiber Products Ltd
Hollands Road
Haverhill, Suffolk
England CB9 8PR

Tel: +44 (0) 1440-706441
Fax: +44 (0) 1440-762044
E-mail: sales@afpgco.com

**Advanced
Fiber
Products**

www.afpgco.com

SuperBullet/Case™

Product Sheet Rev 15321.01

SuperCase™ Spare Power Supply Ordering





Part Number	Input Voltage	Output Voltage	Output Current	Connector Type	AC Plug Type
PS-12V-1HA-389-D	100-240 VAC	12VDC	1.5A	3Pin IP68 D389999	US

SuperBullet™ SuperCase™

Rugged GbE Media Converter for MFOCA®

DDS-M Remote

Field
Deployable
GbE
Solutions

ORDERING INFORMATION ▶	SBSIP-GBE-MF-SM-yy	SBSIP-10GBE-MF-SM	SBSIP-GBE-MF-MM-yy	SCSIP-GBE-MF-xx
SIGNAL ▼				
Ethernet: 10/100/1000 Mbps Channels	1 yy = λ*	0	1 yy = 85 (850nm), 30 (1300nm)	Up to 4 (xx = 01, 02, 03, 04)
Ethernet: 10 Gbps	0	1	0	Contact Factory
Number of Fibers	2 SM	2 SM	2 MM	2 SM
Fiber Connectors (J5)	MFOCA®	MFOCA®	MFOCA®	MFOCA® / LC MM Duplex
Data Connectors (J1,J2,J4,J4)	IP68 RJ45	IP68 RJ45	IP68 RJ45	IP68 RJ45
Power: PoE (J1) or 12VDC D38999 (J6)	PoE	PoE	PoE or 12VDC	PoE or 12VDC

* yy: Blank is 1310nm FP/PIN as standard. Specify 2-digit CWDM TX code: 31=1310, 33=1330, 35=1350, 37=1370, 39=1390, 41=1410, 43=1430, 45=1450, 47=1470, 49=1490, 51=1510, 53=1530, 55=1550, 57=1570, 59=1590 and 61=1610 nm.

SPECIFICATIONS

Item	Description
ETHERNET (10 GbE - Consult factory)	
Protocols 10/100/1000 Mbps	10BASE-T, 100BASE-TX, 1000BASE-T, 1000BASE-X
Frame Size	10,240 byte maximum
Optical Power (GbE Media Converters) <i>SuperBullet™ & SuperCase™</i> (1310 nm FP/PIN Standard)	Transmitter: -9 dBm Minimum, -3 dBm Maximum Receiver: -20 dBm Minimum, -1 dBm Maximum
Optical Power (One CWDM GbE Media Converter) <i>SuperBullet™ & SuperCase™</i>	Transmitter: 0 dBm Minimum, +3 dBm Maximum Receiver: -20 dBm Minimum, -1 dBm Maximum
GENERAL	
Link Length (single-mode fiber)	Ethernet 10/100/1000 Mbps: Up to 5 km
Operating / Storage Temperature	-35 C to +75 C / -40 C to +85 C

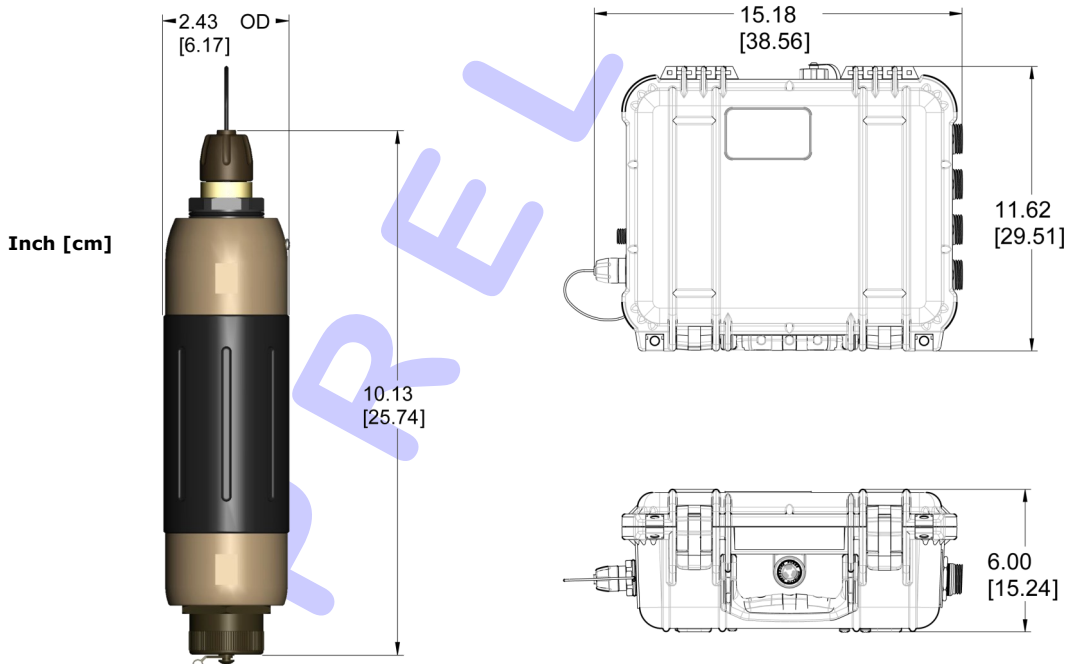

<i>SuperBullet™</i>	Weight
Package	2.2 lbs 1.0 Kg

<i>SuperCase™</i>	Weight
Package	11.8 lbs 5.4 Kg

Advanced Fiber Products LLC
200 East Howard Ave, Suite 244
Des Plaines, IL, USA 60018
Tel: +1-847-768-9001
E-mail: video@afpgco.com

Wholly owned subsidiary of
Advanced Fiber Products Ltd
Hollands Road
Haverhill, Suffolk
England CB9 8PR

Tel: +44 (0) 1440-706441
Fax: +44 (0) 1440-762044
E-mail: sales@afpgco.com

**Advanced
Fiber
Products**

www.afpgco.com

SuperBullet/Case™
Product Sheet Rev 15321.01

- SuperBullet™ - SuperCase™
Rugged GbE Media Converter Solutions for MFOCA®

**Field
 Deployable
 GbE
 Solutions**

Related Products

TFM SuperChassis™



SuperDrum™



40Gb/s SuperMini-Chassis™



MFOCA® Military Tactical Cable Assemblies

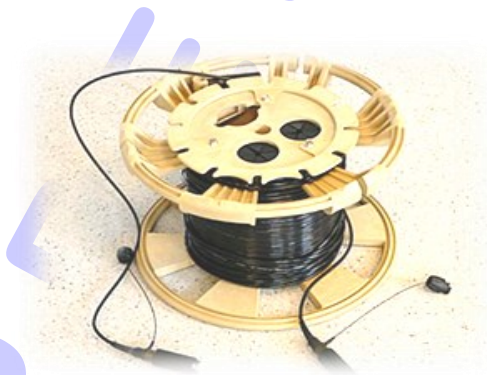

Advanced Fiber Products LLC
 200 East Howard Ave, Suite 244
 Des Plaines, IL, USA 60018
 Tel: +1-847-768-9001
 E-mail: video@afpgco.com

*Wholly owned subsidiary of
 Advanced Fiber Products Ltd
 Hollands Road
 Haverhill, Suffolk
 England CB9 8PR
 Tel: +44 (0) 1440-706441
 Fax: +44 (0) 1440-762044
 E-mail: sales@afpgco.com*



www.afpgco.com

SuperBullet/Case™

Product Sheet Rev 15321.01

Advanced Fiber Products, LLC (AFP-US) develops and manufactures active optical devices engineered and packaged to withstand the rigors of broadcast production and many industrial environments. The devices are designed to convert signals from electrical to optical domain, aggregate, multiplex and de-multiplex them and provide transmission via ruggedized cabling solutions. AFP also offers a wide range of ancillary components in addition to specialized fiber assemblies related to high performance optical hermeticity, laser-to-fiber or fiber-to-detector delivery and integration into complete packaging solutions. AFP-US located near Chicago, Illinois, USA is a wholly owned subsidiary of **Advanced Fiber Products Ltd. (AFP)**. The company is headquartered at Haverhill, near Cambridge in the United Kingdom.

Advanced Fiber Products reserves the right to change or discontinue any product or service in this publication and advises customers to obtain the latest versions of publications before placing orders. Patents are pending. Advanced Fiber Products standard warranty conditions apply and are available upon request. Advanced Fiber Products customers using its products in life preserving applications where the reasonable malfunction of the products might be expected and may result in personal injury, agree to indemnify Advanced Fiber Products against all such improper use and any consequential damages. Advanced Fiber Products makes no representations or warranties that the products are free from patent, copyright or intellectual property rights. Standard Terms and Conditions of sale apply and are available on request.